

Schluter® - KERDI-DRAIN

6 inch stainless steel grate

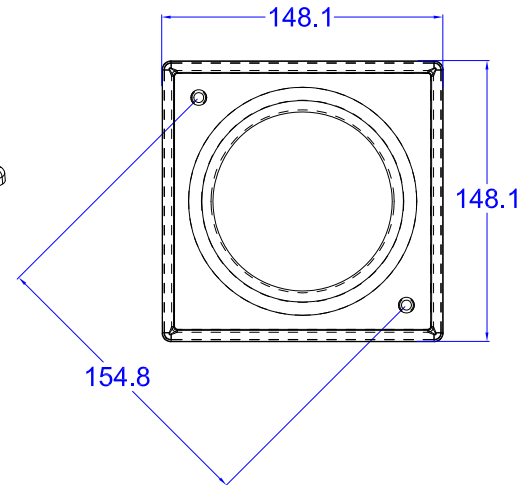

Flow Through Area = 5153.54 mm²

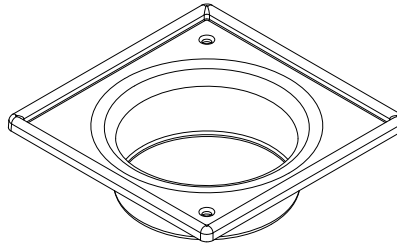
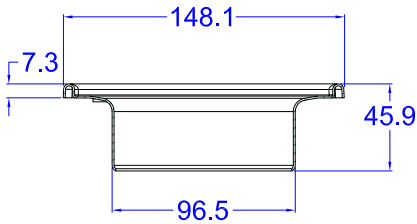
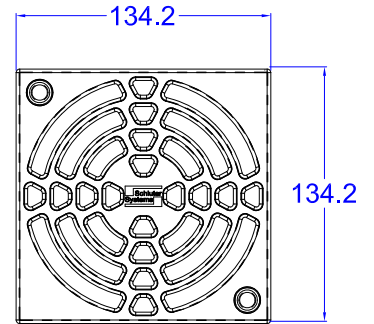
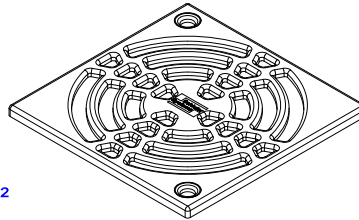

Scale: N.T.S.